







## Rain shower with wall fixing 300 mm - Matte Black

IMO

28 679 670



- 450mm projection
- rain shower Ø 300 mm
- PURE RAIN, max. flow rate 14 l/min (at 3 bar)
- Function from: 10 l/min
- rosette 65 x 65 mm
- 1/2" connection
- with anti-scale system
- quick clearing
- WRAS 1707033

	Matte Black	28 679 670-33
	Chrome	28 679 670-00
	Brushed Platinum	28 679 670-06
	Platinum	28 679 670-08
	Brushed Durabronze (23kt Gold)	28 679 670-28
	Brushed Chrome	28 679 670-93
	Brushed Dark Platinum	28 679 670-99

### Recommended miscellaneous



- Concealed wall elbow -** 35 085 970 90
- min. recess depth 90 mm
  - max. recess depth 163 mm

28 679 670

mm [inches]

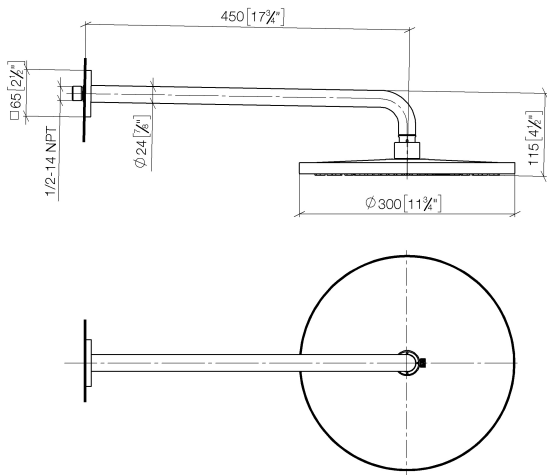

Flow rate chart

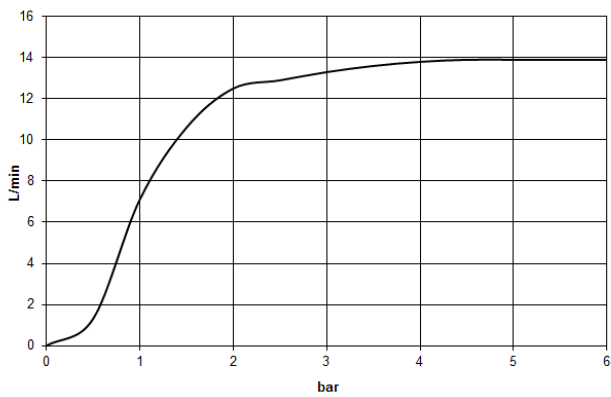

Certificates

WRAS\_2212012. LGA\_29235.

28 679 670

